

FIRE AND SECURITY

AUTRO SAFE

Self Verify®

AutroSafe Interactive Fire-Alarm System



Interfacing Analogue Addressable Loops

Loop Protocols BS-3, BS-30, BS-60,
BS-80, BS-90 and BS-100

COPYRIGHT ©

This publication, or parts thereof, may not be reproduced in any form, by any method, for any purpose.

Autronica Fire and Security AS and its subsidiaries assume no responsibility for any errors that may appear in the publication, or for damages arising from the information in it. No information in this publication should be regarded as a warranty made by Autronica Fire and Security. The information in this publication may be updated without notice.

Product names mentioned in this publication may be trademarks. They are used for identification purposes only.



Table of Contents

1. Introduction	3
1.1 About the Handbook	3
1.2 The Reader	3
2. Loop Interface BSD 330	4
2.1 Description	4
2.2 Dimensions	4
2.3 Technical Specifications	5
2.4 Indicators	5
3. Planning 6	
3.1 Maximum Number of Analogue Addressable Loops Connected to an AutoSafe Panel	6
3.1.1 General	6
3.1.2 How to calculate the maximum number of I/O-modules	6
3.1.3 Calculation example	7
3.2 BS-100 DYFI Functions Supported by AutoSafe	8
3.3 Analogue Addressable Functions Not Supported by AutoSafe	8
3.4 Transfer of Loop Data from Existing Analogue Addressable Systems	9
3.5 Analogue Addressable System Functions Not Imported into AutoSafe	9
3.6 Response Time of Manual Call-Points – British Standards	9
3.7 Control Outputs	10
3.8 Cable Requirements	10
3.9 Connection of Parallel Operation Panels and Display Units	10
4. Installation	11
4.1 Mounting the Loop Interface	11
4.2 Random Delay Period	11
4.3 Connecting the Analogue Addressable Loop to the Loop Interface	12
5. Configuration	13
5.1 Introduction	13
5.2 Examples from the FireSys Configuration Tool	14
5.2.1 Site Reference Number	14
5.2.2 Detector Text and Detector Address	14
5.2.3 Generated Files	15
5.3 BS-100 Loop Data Shown in the AutoSafe Configuration Tool	15
5.3.1 Detection Zone Text	15
5.3.2 Loop-Unit Tag Names – Detector Addresses	15
5.4 Loop Topology for BS-100 Interfaced Detectors	16

5.5	The “Import BS100 Data” Menu	17
5.6	Configuring the Loop Interface – Importing Existing Loop Units.....	18
5.7	Configuring the Loop Interface – Adding Loop Units Manually	22
5.8	Configuring Properties for the Loop	22
5.9	Configuring Properties for each Loop Unit.....	23
5.10	Configuring Properties for Analogue Addressable Detection Zones	23
5.11	Verifying Imported Loop Data	23
5.12	Configuring Control Outputs.....	23
6.	Commissioning	24
6.1	Commissioning Procedure	24
6.2	Short-Circuit Test	24
6.3	Verifying the Loop Interface	25
7.	Reader’s Comments	27

1. Introduction

1.1 About the Handbook

This handbook describes how to successfully connect and interface analogue addressable detectors to the AutoSafe system, using the *BS-100 Loop Interface, BSD-330*.

This includes detectors used in systems BS-3, BS-30, BS-60, BS-80, BS-90 and BS-100.

1.2 The Reader

The handbook is intended for use by trained and qualified Autronica Fire and Security service/technical personnel responsible for the installation, configuration and commissioning of the AutoSafe Interactive Fire-Alarm System.

2. Loop Interface BSD-330

2.1 Description

The BS-100 Loop Interface BSD-330, referred to as **Loop Interface** throughout this handbook, is used as an interface between the AutoSafe detector loop protocol and analogue addressable loop protocols. The Loop Interface makes it possible to connect analogue addressable detectors to the AutoSafe system, including detectors used in systems BS-3, BS-30, BS-60, BS-80, BS-90 and BS-100.

The Loop Interface is easily plugged onto a mounting rail inside the AutoSafe Fire-Alarm Control Panel (BS-310/320) or the Controller (BC-320).

One analogue addressable loop, with a maximum of 99 detectors and manual call-points (maximum 99 addresses), can be connected to each Loop Interface.



2.2 Dimensions

95x 89x32 mm (depth x height x width)

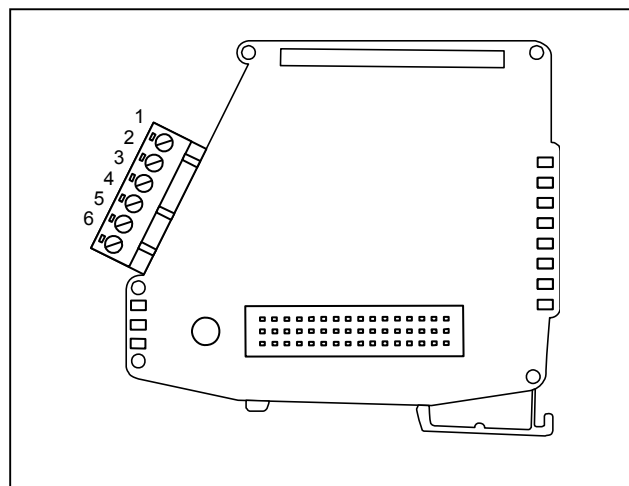

2.3 Technical Specifications

Dimensions (mm)	95 x 89 x 32 (DxHxW)
Weight (g)	81
Materials	Plastic cover
Mounting	Onto a standard 35mm mounting rail inside the Fire-Alarm Control Panel or Controller
Electrical connection	Internal system: plug-in connection Detector loop: plug-in screw terminals (maximum cable dimension 2.5mm ²)
Operating temperature range	-5 to +55 °C
Storage temperature range	-10 to +85 °C
Humidity	5 % - 95 %
EMC requirements	EN 55022 EN 55024 EN 54
Loop output voltage	14VDC ± 0.2V
Maximum current output to loop (14V, BS-100 loop)	160 mA (short-circuit monitored) Fault message at 60 mA (level 1) Fault message at 100 mA (level 2)
Internal current consumption from internal regulated 24VDC	Module, idle 12mA Answer pulses: approx. 40mA Max. 99 detectors: approx. 30mA (number of detectors x 0,3mA) Max. with 99 detectors: approx: 82mA
Internal current consumption from internal 5VDC	38 mA
Maximum loop resistance	30 Ohm
Compatibility	AutroSafe Software Version 3.5.0, or later version
Maximum number of addresses on BS-100 loops	99
Detector loop output control	One transistor output (open collector) 100mA. Controlled by all detectors on the loop.

2.4 Indicators

The Loop Interface has eight LEDs.

The eight LEDs represent the following:

LED 1 (green): Power (blinking light)

LED 2 (green): ASSP communication*

LED 3 (green): AI_Com+ com.**

LED 4: (yellow): Error (blinking light in the event of an error)

LED 5 (yellow): Disablement

LED 6 (yellow): Fault

LED 7 (yellow): Prealarm

LED 8 (red): Alarm

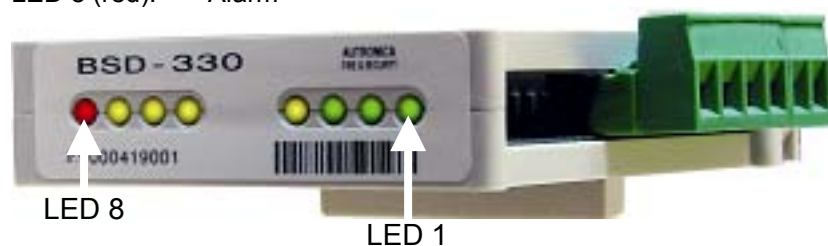

*ASSP: Autronica Standard Short Protocol (communication protocol for BS-100 loop communication)

** AI_Com+ com: AutroSafe Loop Communication (communication protocol for the AutroSafe loop communication)

3. Planning

3.1 Maximum Number of Analogue Addressable Loops Connected to an AutoSafe Panel

3.1.1 General

When interfacing analogue addressable loops to the AutoSafe system, the loops should be distributed on several AutoSafe panels (BS-320/BC-320).

- A maximum of eight Loop Interfaces can be mounted in one AutoSafe panel when using Power Module BSS-310A (BSS-310A is the latest version).
- A maximum of three Loop Interfaces can be mounted in one AutoSafe panel when using Power Module BSS-310.

3.1.2 How to calculate the maximum number of I/O-modules

This chapter provides information on how to calculate the maximum number of I/O-modules in an AutoSafe panel (BS-320/BC-320) equipped with BSD-330 and standard AutoSafe I/O-modules.

Power module BSS-310 and BSS-310A supply I/O-modules with regulated 24VDC and 5VDC.

The maximum number of installed I/O-modules is determined by the maximum current consumption from the internal regulated 24VDC and 5VDC.

MODULES	Max. current output		Max.current consumption each I/O-module		
			Normal condition		Alarm condition
	5VDC reg	24VDC reg	5VDC reg	24VDC reg	24VDC reg
Power modules: Max. output from BSS-310 Max. output from BSS-310A	100mA 400mA	840mA 840mA			
BSD-330, BS-100 Loop Interface			38mA	85mA	90mA
BSD-310, AutoSafe standard loop module			1,6mA	75mA	140mA
BSD-311, AutoSafe high-power loop module			1,6mA	75mA	280mA
BSB-310, Relay output module			1,5mA	15mA	15mA
BSE-310, Alarm input module			4mA	15mA	15mA
BSE-320, Alarm input module			4mA	7mA	7mA
BSJ-310, Output control module			1,5mA	7mA	7mA
BSL-310, Internal communication module			2,7mA	22mA	22mA

The table on the previous page shows that the most critical I/O-modules in this context are the BSD-loop modules. When configuring the number of BSD-loop modules, the “worst-case scenario” has to be taken into consideration; that is in the event of an alarm on the detector loop with a maximum number of activated loop sounders BBR-200. This may give a current consumption of 140mA for power module BSD-310 and 280mA for power module BSD-311.

The worst case is in the event of an alarm on multiple BSD-311 loops with a maximum number of activated loop sounders BBR-200.

It is important that an individual calculation of the panel functions is done for each panel installation to ensure that the panel and functions will work properly with the installed I/O-modules.

An exact figure for calculated I/O-modules is not possible before the total configuration for the panel is known.

Note that the description above refers to 24V regulated DC. Current consumption to sounder outputs (BSB-310) and control outputs are supplied from the 27,3V battery, and not from the 24V regulated DC.

3.1.3 Calculation example

The table below shows a calculation example.

Modules	24VDC reg	5VDC reg
5 BSD-330 modules (85mAx5)	425mA	190mA
2 BSD-310 modules (140mAx2)	280mA	3,2mA
1 BSB-310 module	15mA	1,6mA
2 BSJ-310 module (7mAx2)	14mA	3,0mA
1 BSL-310 module	22mA	2,7mA
Total	756mA	200,5mA

756mA from regulated 24VDC is OK. This means that we can use both BSS-310 and BSS-310A.

200,5mA from regulated 5VDC is too much for BSS-310.

Conclusion: the configuration is OK if the power module BSS-310A is used.

3.2 BS-100 DYFI Functions Supported by AutoSafe

The following BS-100 DYFI functions are supported by AutoSafe, using the Loop Interface:

- transient filter
- ATS values presented as SMS values
- detector alarm limits (high/normal/low)
- loop characteristics (normal/long)
- 24-character detector addresses (tag names), and 34-character detection-zone (DZ) addresses
- panel addresses A-Z
- possibility of importing files, including FireSys text (34 characters), to the AutoSafe Configuration Tool (BSETECT.DAT file)

3.3 Analogue Addressable Functions Not Supported by AutoSafe

The following analogue addressable functions are *not* supported by AutoSafe using the Loop Interface:

- pollution algorithm
- address control
- calculation of performance factor
- “smouldering fire” algorithm
- printout of detector sensitivity
- printout of detector sensitivity beyond limit
- printout of customer-specified configuration from front panel
- BK-50 functions (zone-control unit in the BS-60 system)

3.4 Transfer of Loop Data from Existing Analogue Addressable Systems

Analogue addressable systems BS-100, BS-80 and BS-90 use the FireSys configuration tool to generate a BSDetect.DAT. file, which includes installation reference numbers and detector text. If such a file is available, the data can easily be imported using an import function in the AutoSafe Configuration Tool. See chapter 5 in this handbook.

If a BSDetect.DAT. file is not available, this information has to be added manually. See chapter 5 in this handbook.

3.5 Analogue Addressable System Functions Not Imported into AutoSafe

Not all functions are imported from systems BS-100, BS-80 and BS-90 into the AutoSafe system. These include the following:

- All control functions must be defined manually in the AutoSafe Configuration Tool
- Additional text for printers used in the BS-100 system cannot be implemented in the AutoSafe system
- Alarm-sounder outputs must be defined manually in the AutoSafe Configuration Tool
- Zones configured with the FireSys configuration tool cannot be imported into the AutoSafe system
- Group disablements configured with the FireSys configuration tool must be defined manually in the AutoSafe Configuration Tool

3.6 Response Time of Manual Call-Points – British Standards

According to British Standards, an alarm signal must appear on the panel display within three seconds of the activation of a manual call-point (response time). In order to meet this requirement, manual call-points cannot be assigned an address higher than 40 on an analogue addressable loop.

3.7 Control Outputs

Each Loop Interface (BSD-330) has one control output (open collector). This control output is activated in the event of an alarm on the corresponding analogue addressable loop.

The control output can be used as a common control output for all loop units on an analogue addressable loop. The functionality of the control output, and particularly the reset function, is similar to standard control outputs.

3.8 Cable Requirements

The Loop Interface has a plug-in terminal block for cables up to 2.5mm².

3.9 Connection of Parallel Operation Panels and Display Units

BU-100 Parallel Operation Panels and BU-70 Display Units can be connected to AutoSafe panels by use of a protocol converter BSL-337 and an RS-232/20mA CL Converter BSL-12/2. There can be a maximum of 32 panels divided on 2x16 panels, connected to 2 serial communication ports on EAU-321.

4. Installation

4.1 Mounting the Loop Interface

- Plug the Loop Interface(s) onto the mounting rail inside the AutoSafe Fire-Alarm Control Panel (BS-310/320) or the Controller (BC-320)
- Note that the Power Module BSS-310A must always be mounted in the lowest position, with the Communication Module BSL-310 mounted directly above BSS-310A

For information on limitations and guidelines, see chapter 3.1.

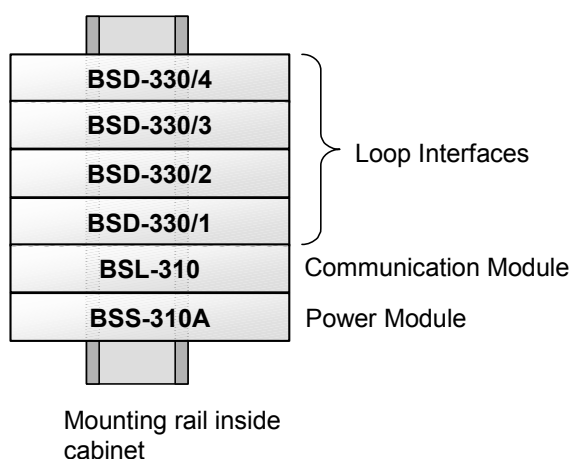

4.2 Random Delay Period

Shortly after power-up, each BSD-330 Loop Interface will carry out a short-circuit test of its loop output. This test causes a high current consumption for approximately 40ms. If more than 3 Loop Interfaces carry out this test simultaneously, the BSS-310 or BSS-310A will not be able to supply the current that is required. Consequently, the Loop Interfaces will not start and will continuously attempt to restart.

The BSS-310A power module can supply the current which is required for start-up of a maximum of 3 Loop Interfaces in parallel.

To overcome a start-up problem with more than 3 loop interfaces, a random delay period has been configured for each loop interface. This random delay period makes it possible to start up a maximum of 8 BSD-330s at different delay periods.

The random delay period is printed on the acceptance label on the Loop Interface (BSD-330).

- Note that when installing Loop Interfaces it is important to select modules with different delay periods.

4.3 Connecting the Analogue Addressable Loop to the Loop Interface

- Refer to the drawings below, and connect the analogue addressable loop to the Loop Interface
- Use the plug-in terminal block on the BSD-330, and connect the cables as follows:

Screw Terminal no.	Signal
1	Positive loop output (B)
2	Positive loop return (B')
3	Negative loop output (A)
4	Negative loop return (A')
5	T-output (control output, open collector 100mA)
6	GND

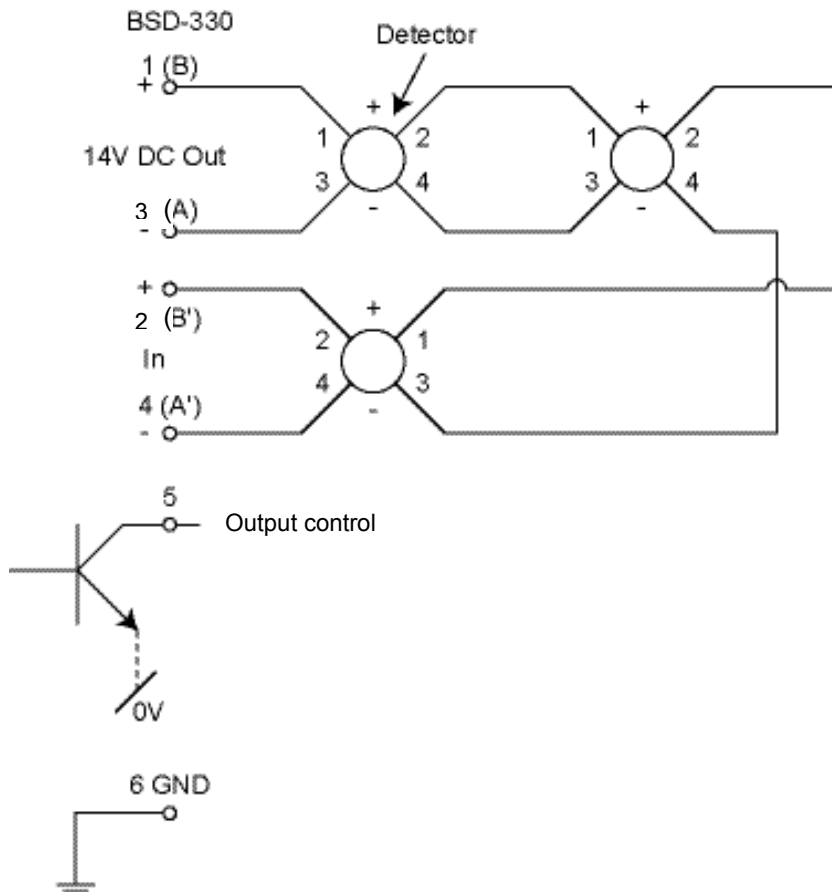

5. Configuration

5.1 Introduction

The AutoSafe Configuration Tool has an import function that allows you to import installation reference numbers and detector text from an existing analogue addressable system, including systems BS-100, BS-80 and BS-90.

The configuration of these systems is done by means of the FireSys configuration tool. The FireSys tool is similar to the AutoSafe Configuration Tool, and is used to generate detector text and control data. The import file which is generated is called "BSDetect.DAT. file".

- If a BSDetect.DAT. file is available, data can easily be imported using the import function in the "Tools" menu. See chapter 5.6.
- If a BSDetect.DAT. file is not available, the loop units and corresponding data have to be added manually using the AutoSafe Configuration Tool. See chapter 5.7.

5.2 Examples from the FireSys Configuration Tool

The screen dumps in this chapter are examples taken from the FireSys configuration tool.

5.2.1 Site Reference Number

The screen dump below shows the “Site Reference Number” where the BSDetect.DAT file is located. This file (S3-2059, for example) is imported into the AutoSafe Configuration Tool .

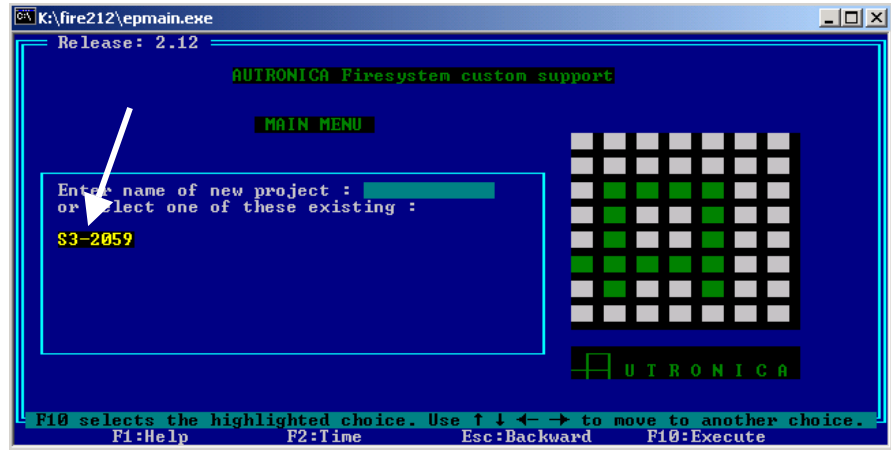

5.2.2 Detector Text and Detector Address

The screen dump below shows the detector text and the detector address to be imported into the AutoSafe Configuration Tool.

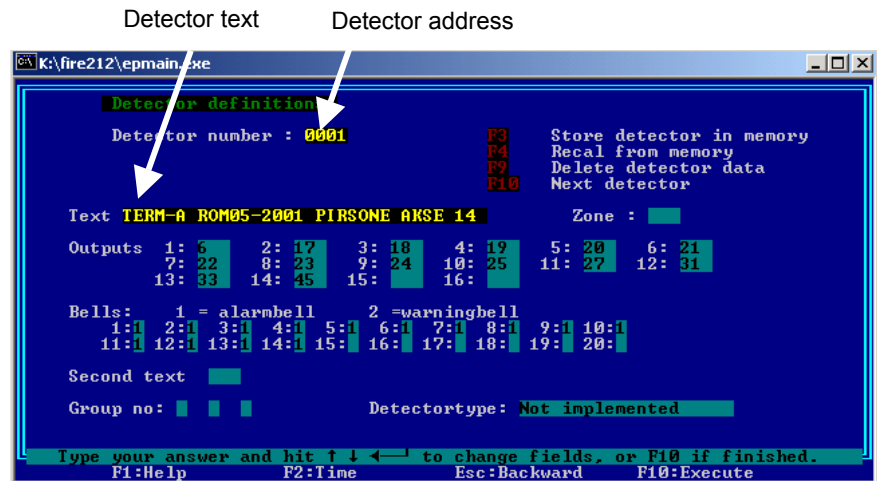

For example:

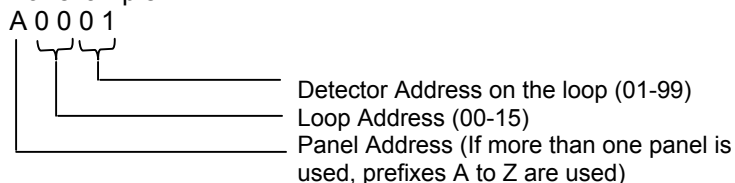

5.2.3 Generated Files

The screen dump below shows a folder with the site reference number (S3-2059 in this example), including the import file BSDETECT.DAT.

Site Reference Number File Name: "BSDETECT.DAT"

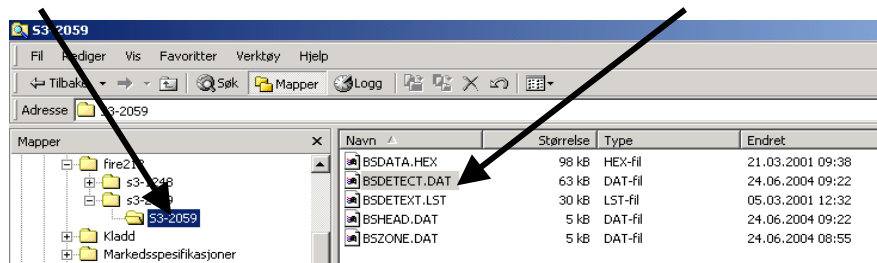

5.3 BS-100 Loop Data Shown in the AutoSafe Configuration Tool

5.3.1 Detection Zone Text

When importing a BSDETECT.DAT. file to the AutoSafe Configuration Tool, each "detector address" (loop units in the BS-100, BS-80 and BS-90 systems) is automatically connected to a detection zone (DZ).

Each detector text is automatically assigned to the detection zone (a maximum of 34 characters).

5.3.2 Loop-Unit Tag Names – Detector Addresses

When importing a BSDETECT.DAT. file to the AutoSafe Configuration Tool, detector addresses defined in the analogue addressable system (for example, 0001) will automatically appear as loop-unit tag names (for example, BS100_LOOP_UNIT, 0001).

If more than one panel is used, prefixes A to Z must be added manually.

5.4 Loop Topology for BS-100 Interfaced Detectors

AutoSafe loop units are addressed by the software in the AutoSafe system with an LSI (Loop Sequence Index), a *loop-specific* index, specifying the exact loop unit *order* on the loop (sequentially numbered). This means that the loop units are addressed according to their physical position on the loop.

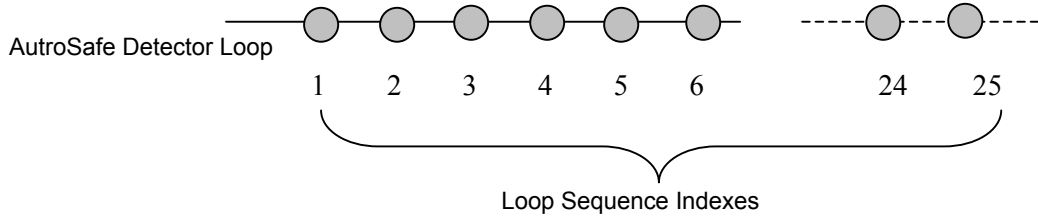

BS-100 detectors are addressed by means of DIP-switches in each detector. The addresses are totally independent of the detectors' physical locations on the loop.

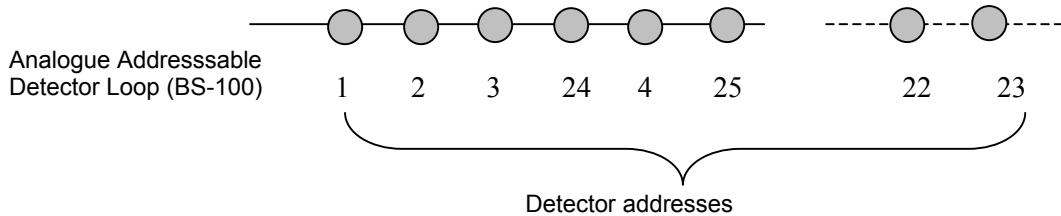

Note that as the addresses of the BS-100 detectors are totally independent of the detectors' physical location on the loop, the position of the BS-100 loop units in the "Tree View" does not show the loop topology.

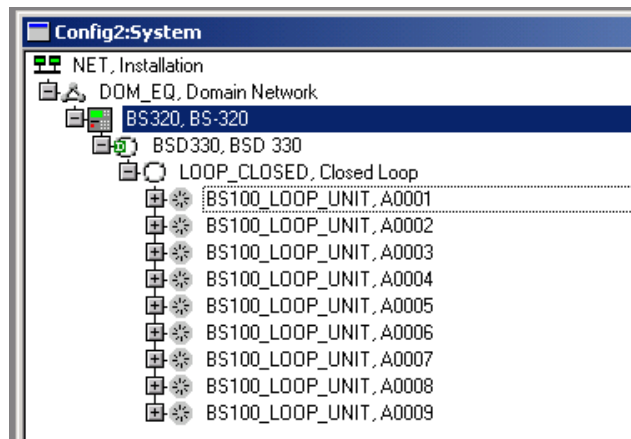

5.5 The “Import BS100 Data” Menu

The AutoSafe Configuration Tool has an import function that allows you to import detector addresses and detector text from an existing analogue addressable system, including systems BS-100, BS-80 or BS-90.

This menu selection is found in the “Tools” menu.

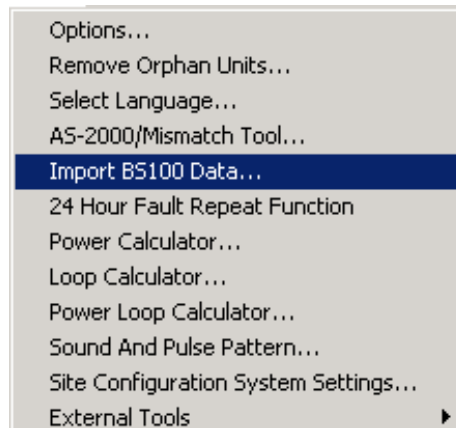

5.6 Configuring the Loop Interface – Importing Existing Loop Units

If a BSDetect.DAT. file with the existing analogue addressable loop data is available, the data can easily be imported into the AutoSafe Configuration Tool using the import function in the “Tools” menu.

- In the “Tree View”, select the panel (BS-310, BS-320 or BC-320)



- Connect the selected panel (for example BS-320) to an operation zone
- In the “Tools” menu, select Import BS100 Data

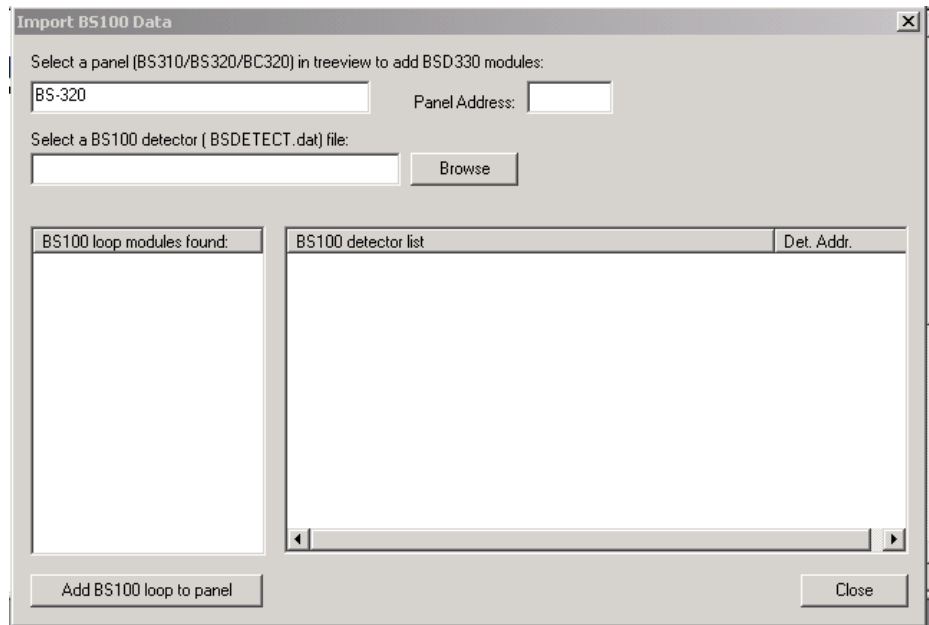

- In the “Tree View”, select the BS-320 panel
- Click the “Browse” button, locate the BSDetect.DAT. file in the FireSys site folder, and click “Open”

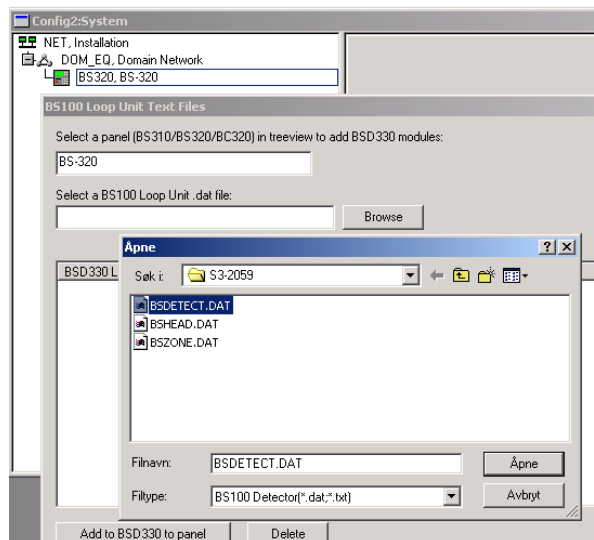

- The number of existing BS-100 loops and the corresponding BSD-330 Loop Interfaces are shown (00-15)

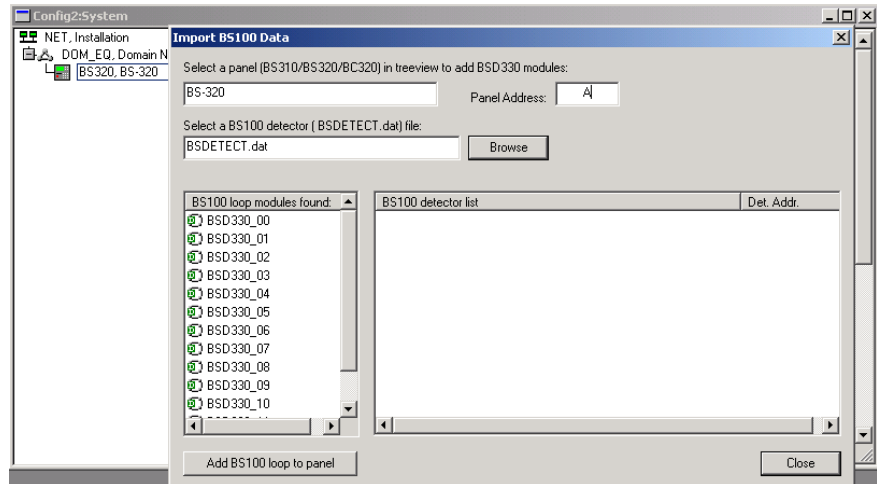

- To view the number of connected loop units (detectors) and the corresponding text, click a selected Loop Interface (for example, BSD330_00), and the text will appear in the window on the right-hand side.

The column “Det. Addr.” (detector address) shows the detector numbers in the analogue addressable system

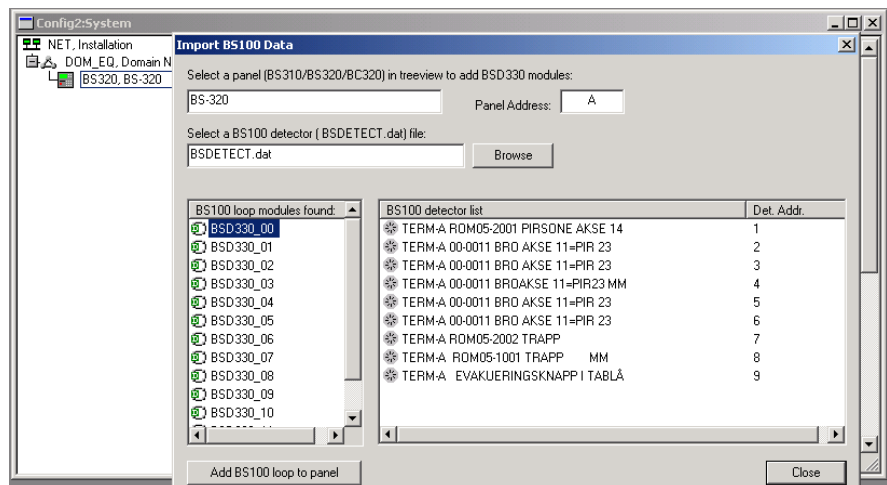

- If more than one panel is used, prefixes A to Z must be added manually (panel address)
- Select the Loop Interfaces that are to be added (you can select one or several), then click the button in the lower left-hand corner (“Add BS100 loop to panel”).

The Loop Interfaces and all loop units will be imported into the AutoSafe Configuration Tool

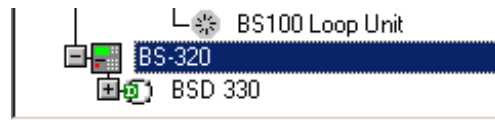

- Expand the “Tree View” for both the Loop Interface and the closed loop (click “+” in front of the icons).

The Loop Units (detectors) and detector addresses will appear in the “Tree View”

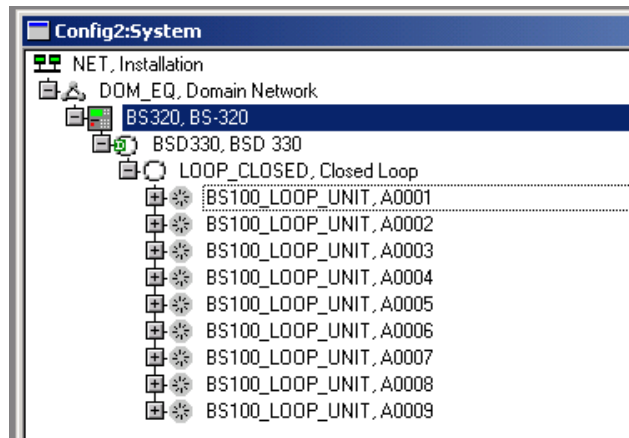

Note that the detector address is now similar to the loop-unit tag name, and is limited to maximum 24 characters.

- Expand the “Tree View” for a loop unit.

The detector text is now shown as the detection zone (DZ) text for that particular detector

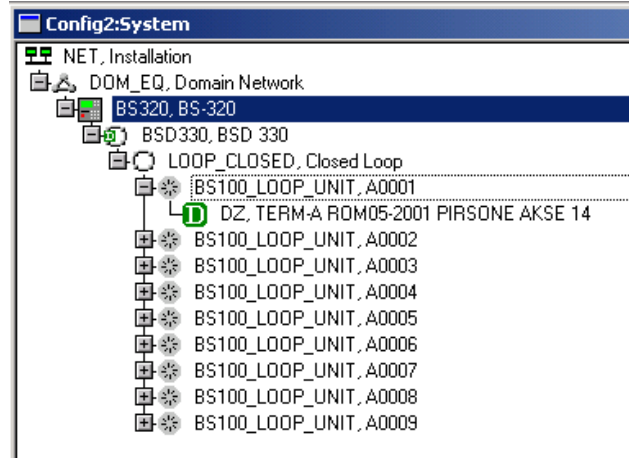

Note that the length of the detection zone text will not be changed (a maximum of 34 characters).

5.7 Configuring the Loop Interface – Adding Loop Units Manually

- Add the Loop Interface (BSD-330) to a panel (BS-310/320, BC-320) in the “System View”
- Add a closed loop to the Loop Interface (BSD-330)

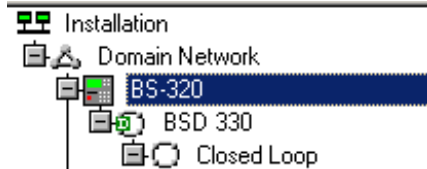

- Add a BS-100 loop unit to the closed loop, then connect it to a detection zone

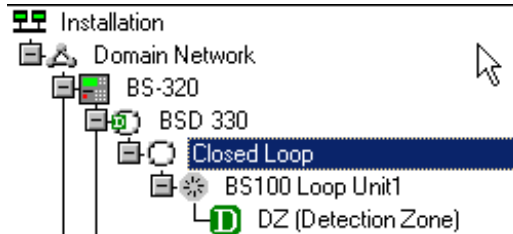

- Continue adding more Loop Interfaces, if necessary, and connect each unit to a detection zone
- If several Loop Interfaces are to be added, make sure that each Loop Interface is given a unique name, for example, BSD-330/1, BSD-330/2 etc.

5.8 Configuring Properties for the Loop

The following shows the “Property View” for the Loop Interface:

- In the “Property View”, determine the appropriate value for each property

Property Name	Description
Filter Constant	Filter function for the entire loop. Response period: Normal or Long
Name	The name of the unit, maximum 24 characters

5.9 Configuring Properties for each Loop Unit

The following shows the “Property View” for a loop unit:

- In the the “Property View”, determine the appropriate value for each property

Property Name	Description
Alarm Limit	High, Normal and Low alarm limit
Point Delay	ON/OFF
Name	The name of the loop unit, maximum 24 characters (Tag Name)

5.10 Configuring Properties for Analogue Addressable Detection Zones

The following shows the “Property View” for a detection zone (DZ) imported from an analogue addressable system.

- In the “Property View”, determine the appropriate value for each property

Property Name	Description
DZ Action	Immediate coincidence delayed action, SOLAS action, delayed coincidence
DZ T1 Delay	120 (delay period)
DZ T2 Delay	480 (delay period)
DZ Name	Maximum 34 characters

5.11 Verifying Imported Loop Data

If you have imported existing analogue addressable loop data (from the import file BSDETECT.DAT), the loop data should be verified.

- Verify that the imported data is correct (AutoSafe Configuration Tool)
- Verify the detection zone text (maximum 34 characters) and the loop-unit tag name

5.12 Configuring Control Outputs

Each Loop Interface (BSD-330) has one control output (open collector).

The control output can be used as a common control output for all loop units on an analogue addressable loop. The functionality of the control output, and particularly the reset function, is similar to standard control outputs.

6. Commissioning

6.1 Commissioning Procedure

- Refer to the standard commissioning procedure for the AutoSafe system, and download the configuration files
- Start the initialising procedure

For further information, refer to the AutoSafe Commissioning Handbook.

6.2 Short-Circuit Test

During power-up of the Loop Interfaces (BSD-330), an automatic short-circuit test of the detector loop is carried out. This test causes a current pulse on the +24V output from the BSS-310A power module.

- Make sure that Loop Interfaces with different delay periods have been used during installation (see Installation, chapter 4)

The BSS-310A power module can supply the current which is required for up to three Loop Interfaces. If more than three Loop Interfaces are used, a system restart will occur. To overcome this problem, a random delay period has been configured for each Loop Interface.

A random delay period is printed on the acceptance label on the Loop Interface (BSD-330).

6.3 Verifying the Loop Interface

- Refer to the picture below, and verify that LEDs 1 to 8 are operating as described in the event of a disablement, fault, prealarm and/or alarm



- LED 1 (green): Power. Pulsing light during normal operation
- LED 2 (green): ASSP Communication*. Pulsing light when data is running on the ASSP databus
- LED 3 (green): AI_Com+com*. Pulsing light when data is running on the AI_Com+ databus
- LED 4 (yellow): Pulsing light in the event of an error in the Loop Interface
- LED 5 (yellow): Steady light when addresses are disabled
- LED 6 (yellow): Steady light upon detector failure
- LED 7 (yellow): Steady light at prealarm
- LED 8 (red): Steady light at alarm

*ASSP: Autronica Standard Short Protocol (communication protocol for BS-100 loop communication)

** AI_Com+ com: AutoSafe Loop Communication (communication protocol for the AutoSafe loop communication)

7. Reader's Comments

Please help us to improve the quality of our documentation by returning your comments on this manual:

Title: *Interfacing Analogue Addressable Loops, AutoSafe Interactive Fire-Alarm System*

Reference number: *P-ASAF-BS100/EE Rev.B, 2006-10-26*

Your information on any inaccuracies or omissions (with page reference):

Please turn the page

Suggestions for improvements

Thank you! We will investigate your comments promptly.

Would you like a written reply? Yes No

Name: -----

Title: -----

Company: -----

Address: -----

Telephone: -----

Fax: -----

Date: -----

Please send this form to: Autronica Fire and Security AS
 N-7483 Trondheim
 Norway

Tel: + 47 73 58 25 00

Fax: + 47 73 58 25 01

www.autronicafire.com

Autronica Fire and Security AS is an international company, based in Trondheim, Norway, and has a world-wide sales and service network. For more than 40 years Autronica's monitoring systems have been saving lives and preventing catastrophes on land and at sea. Autronica Fire and Security's most important business area is fire detection and security. Autronica Fire and Security stands for protecting life, environment and property.

Quality Assurance

Stringent control throughout Autronica Fire and Security assures the excellence of our products and services. Our quality system conforms to the Quality System Standard NS-EN ISO 9001, and is valid for the following product and service ranges: marketing, sales, design, development, manufacturing, installation and servicing of

- fire-alarm and security systems
- petrochemical, oil and gas instrumentation systems for monitoring and control

In the interest of product improvement, Autronica Fire and Security reserves the right to alter specifications according to current rules and regulations.

Autronica Fire and Security AS

Fire and Security, Trondheim, Norway. Phone: + 47 73 58 25 00, fax: + 47 73 58 25 01

Oil & Gas, Stavanger, Norway. Phone: + 47 51 84 09 00, fax: + 47 51 84 09 99

Maritime Sales, Spikkestad, Norway. Phone: + 47 31 29 55 00, fax: + 47 31 29 55 01

Visit Autronica Fire and Security's website: www.autronicafire.com